

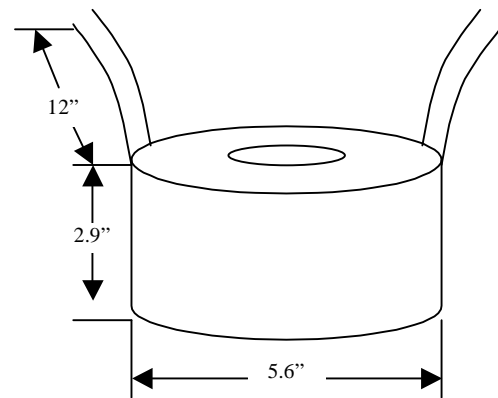

The 500VA toroidal transformers are commonly used in the noise sensitive equipment, high-end audio products, stepper motor supply, or servo motor supply. They are specially designed to work on all standard 115V or 230V at 50Hz or 60Hz. These transformers have heavier gauge wires than the normal requirement to avoid the copper lost during the full power output. The dielectric test is more than 3500V in between primary and secondary coils. Please see the test data for short circuit and open circuit.

In most of the cases, this transformer can be output 20% more power from its rating at 60Hz power source without any problem. This transformer comes with 2 rubber pads and all mounting hardware.

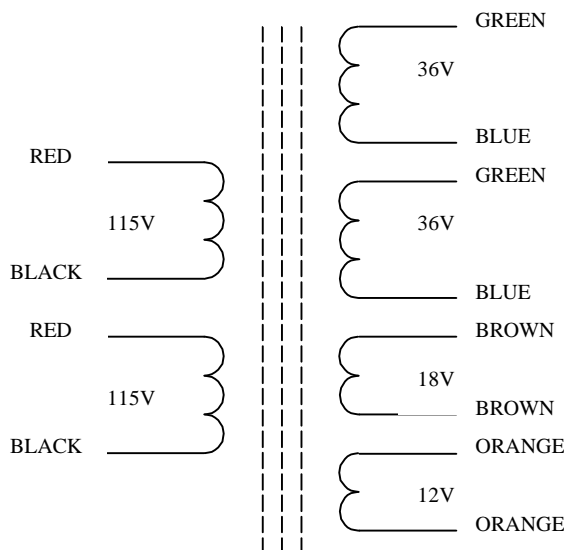

Weight = 11 LB

<b>Open Circuit Test (core loss test):</b> TEST CONDITION: Apply variable voltage to primary coils (in parallel). Set voltages 120 and 140VAC at 60Hz. No load on secondary coils. Measure the primary current and input power.	V <sub>oltage input</sub>	C <sub>urrent input</sub>	P <sub>ower lost</sub>
	120V 140V	.04A .09A	5W 10W
<b>Short Circuit Test (copper loss test):</b> TEST CONDITION: Short all secondary coils, and apply variable voltage to (parallel) primary coils. Varies the voltage from 0-20VAC at 60Hz and freeze the voltage at rated primary current.	V <sub>oltage input</sub>	C <sub>urrent rated</sub>	P <sub>ower lost</sub>
	5.3V	4.2A	22W
<b>Load Test (operation test):</b> TEST CONDITION: Input 120VAC 60Hz to the primary coils (in parallel), Output 1 and 2 in parallel to load, and measure voltage and current at different load levels.	V <sub>oltage output</sub>	C <sub>urrent output</sub>	P <sub>ower output</sub>
	36.7V	0.0A	0W
	35.3V	7.0A	247W
	34.4V	13.6A	466W