

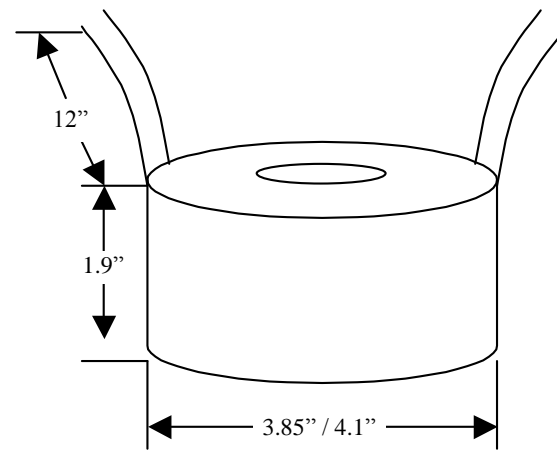

The 100VA toroidal audio power transformers have static shield between primary and secondary coils to improve the isolation and noise interference. And they also have the magnetic shield around the outside to reduce the magnetic leakage. All the added features will make these transformers to be the best audio transformers. They are specially designed to work on all standard 115V or 230V at 50Hz or 60Hz. These transformers have heavier gauge wires than the normal requirement to avoid the copper lost during the full power output. The dielectric leakage current test is up to 3500Vac in between primary and secondary coils.

This transformer comes with 2 rubber pads, holding disk and center bolt assembly.

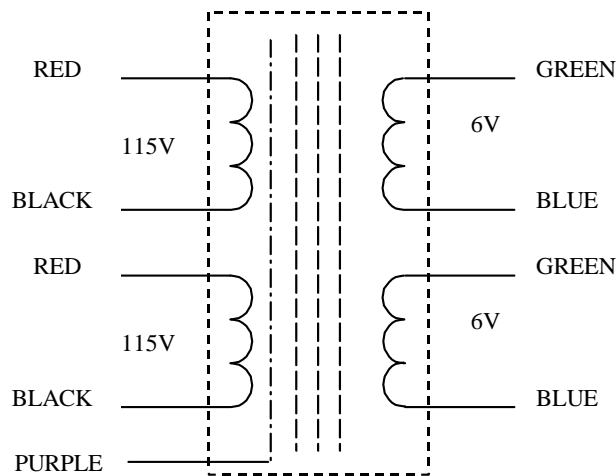

Weight = 3.5 LB

<b>Open Circuit Test (core loss test):</b> TEST CONDITION: Apply variable voltage to primary coils (in parallel). Set voltages 120 and 140VAC at 60Hz. No load on secondary coils. Measure the primary current and input power.	V <sub>voltage input</sub>	C <sub>Current input</sub>	P <sub>Power lost</sub>
	120V 140V	.010A .015A	1.2W 2.1W
<b>Short Circuit Test (copper loss test):</b> TEST CONDITION: Short all secondary coils, and apply variable voltage to (parallel) primary coils. Varies the voltage from 0-20VAC at 60Hz and freeze the voltage at rated primary current.	V <sub>voltage input</sub>	C <sub>Current rated</sub>	P <sub>Power lost</sub>
	10.8V	0.87A	9.4W
<b>Dielectric Test (leakage current):</b> TEST CONDITION: Apply high voltage probe to primary coils and check the leakage current to ground wire (purple) and secondary coils.	V <sub>voltage</sub>	C <sub>Current to GN</sub>	C <sub>Current to 2nd</sub>
	3500Vac	571uA	135uA
<b>Load Test (operation test):</b> TEST CONDITION: Input 120VAC 60Hz to the primary coils (in parallel), Output 1 and Output 2 in parallel to load, and measure voltage and current at different load levels.	V <sub>voltage output</sub>	C <sub>Current output</sub>	P <sub>Power output</sub>
	6.3V	0.0A	0W
	5.8V	15.4A	89W
	5.6V	22.6A	127W