

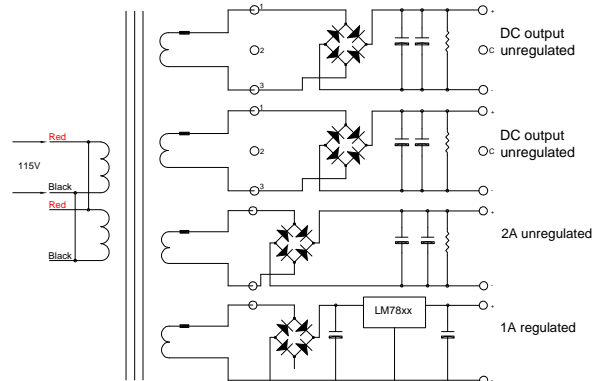

These power supplies are designed for used in the servo motor drive and high over loaded applications. They will work on both standard 115V and 230V at 50Hz or 60Hz. This toroidal transformer has heavier gauge wires then the normal requirement to avoid the copper lost during the full load output and over load output. It can easily handle up to 200% over load for few minutes.

The power supply has a flexible add on option that allows more outputs as needed. Those isolated outputs can be used as logic control or encoder power supply. The main output has 2 large capacitors (10000uF x2) to guaranty the output ripple to minimum.

The chassis is made of 3/32" thick aluminum for strength and heat dissipation from rectifier and linear regulators. It will work continuous without any over heat problem.

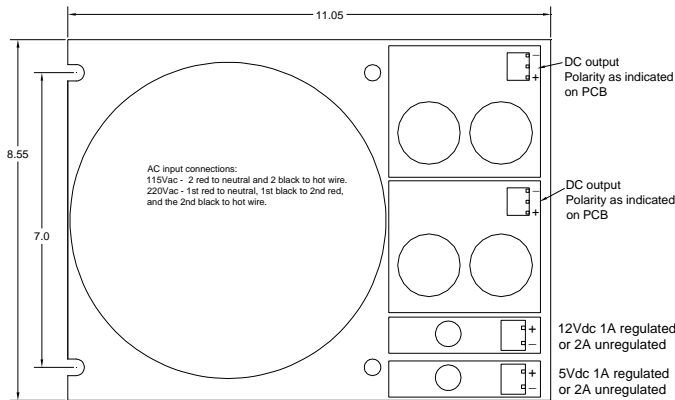

**AC power connections:**

115Vac – 2 red wires to neutral & 2 black wires to hot.  
220Vac – 1<sup>st</sup> red wire to neutral, 1<sup>st</sup> black wire to 2<sup>nd</sup> red wire, and the 2<sup>nd</sup> black wire to hot.

Part No.	Output 1 & 2	Output 3	Output 4	Note:
PS-15N56	56Vdc 13A	-	-	Both output 1 and 2 can be wired in series for double voltage or in parallel for double current. Optional fuse module is available.  * regulated output
PS-15N56N17	56Vdc 13A	17Vdc 2A	-	
PS-15N56N17R5	56Vdc 13A	17Vdc 2A	5Vdc 1A *	
PS-15N56N24	56Vdc 13A	24Vdc 2A	-	
PS-15N56N24R5	56Vdc 13A	24Vdc 2A	5Vdc 1A *	
PS-15N56R5	56Vdc 13A	5Vdc 1A *	-	
PS-15N56R5R12	56Vdc 13A	5Vdc 1A *	12Vdc 1A *	
PS-15N56R12	56Vdc 13A	12Vdc 1A *	-	