

These power supplies are designed for used in the servo motor drive and high over loaded applications. They will work on both standard 115V and 230V at 50Hz or 60Hz. This toroidal transformer has heavier gauge wires then the normal requirement to avoid the copper lost during the full load output and over load output.

The power supply has a flexible add on option that allows more outputs as needed. Those isolated outputs can be used as logic control or encoder power supply. The main output has 2 large capacitors (5600uF x2) to guaranty the output ripple to minimum.

The chassis is made of 3/32" thick aluminum for strength and heat dissipation from rectifier and linear regulators. It will work continuous without any over heat problem.

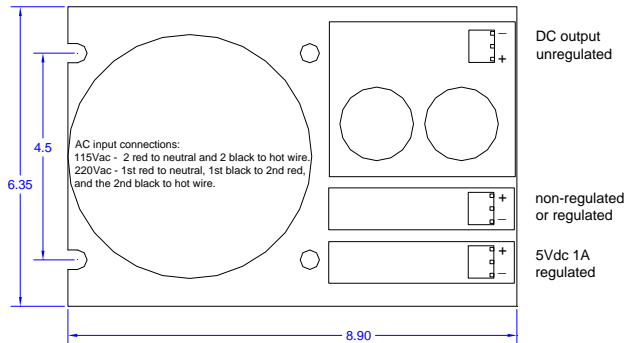

AC power connections:

115Vac – 2 red wires to neutral & 2 black wires to hot.
220Vac – 1st red wire to neutral, 1st black wire to 2nd red wire, and the 2nd black wire to hot.

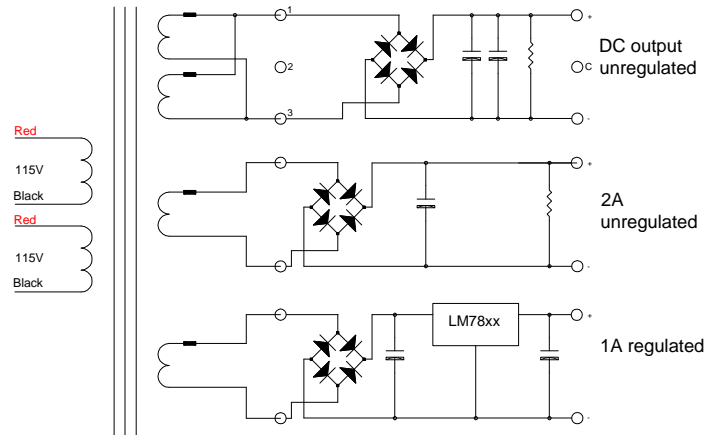

Part No.	Output 1	Output 2	Output 3	Note:
PS-5N80	80Vdc 6A	-	-	Output 2 & Output 3 can be added later as required. Other regulated voltages such as 3.3V, 6V, 8V, and 10V are also available in few days. Optional fuse module is available. * linear regulated output
PS-5N80N17	80Vdc 6A	17Vdc 2A	-	
PS-5N80N17R5	80Vdc 6A	17Vdc 2A	5Vdc 1A *	
PS-5N80N24	80Vdc 6A	24Vdc 2A	-	
PS-5N80N24R5	80Vdc 6A	24Vdc 2A	5Vdc 1A *	
PS-5N80R5	80Vdc 6A	5Vdc 1A *	-	
PS-5N80R5R12	80Vdc 6A	5Vdc 1A *	12Vdc 1A *	
PS-5N80R12	80Vdc 6A	12Vdc 1A *	-	